

LPOW-2415A Power Supply for LIOB Connect Devices

Installation instructions

Instructions de montage

Montageanweisung

Montagevoorschrift

Istruzioni di montaggio

Instrucciones de montaje

Monteringsanvisning

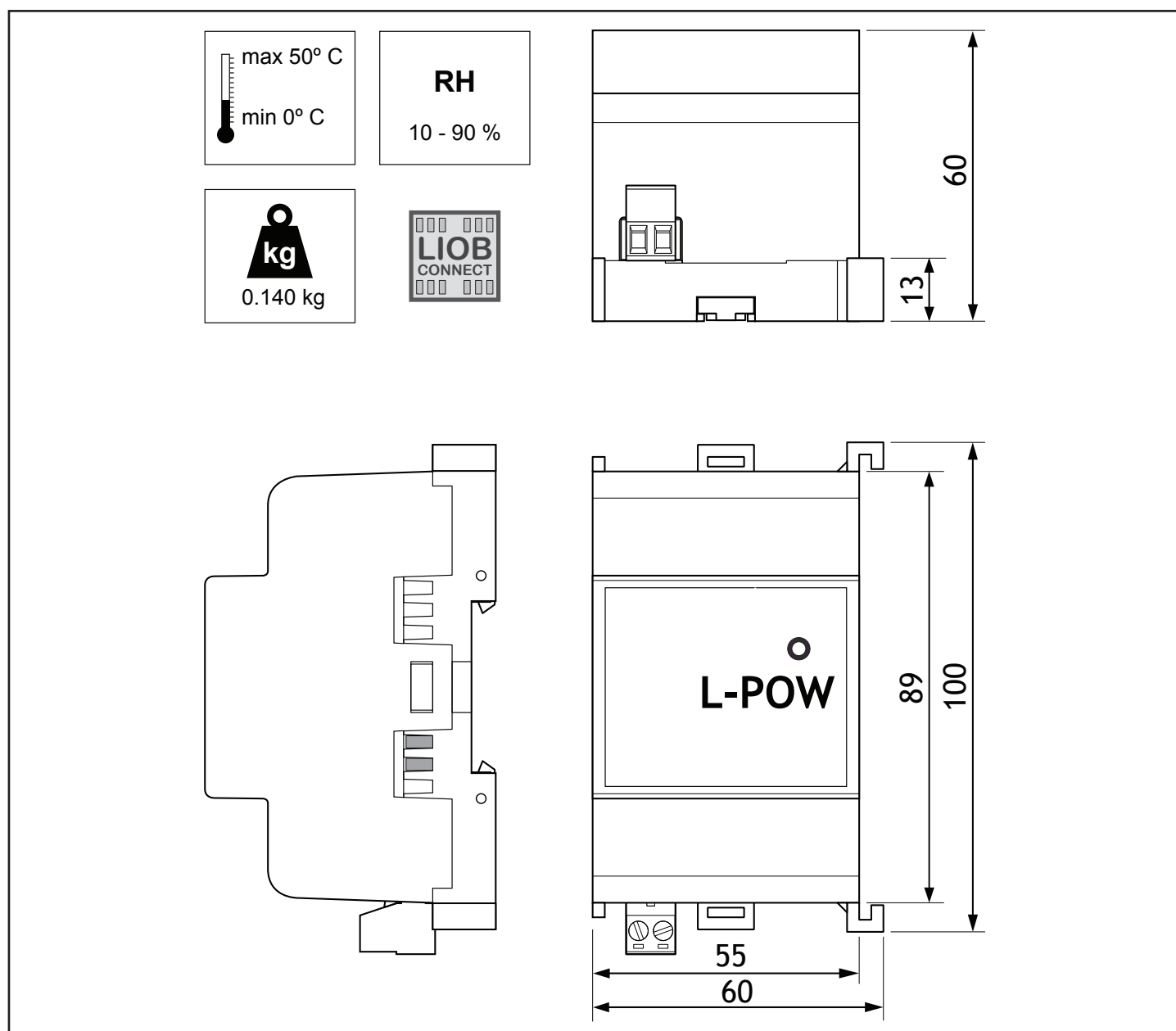

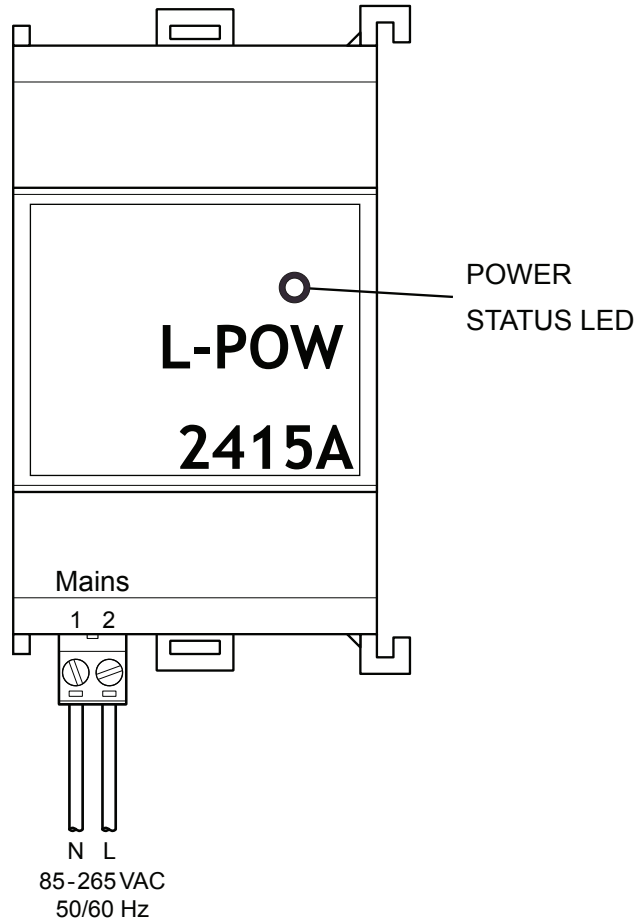
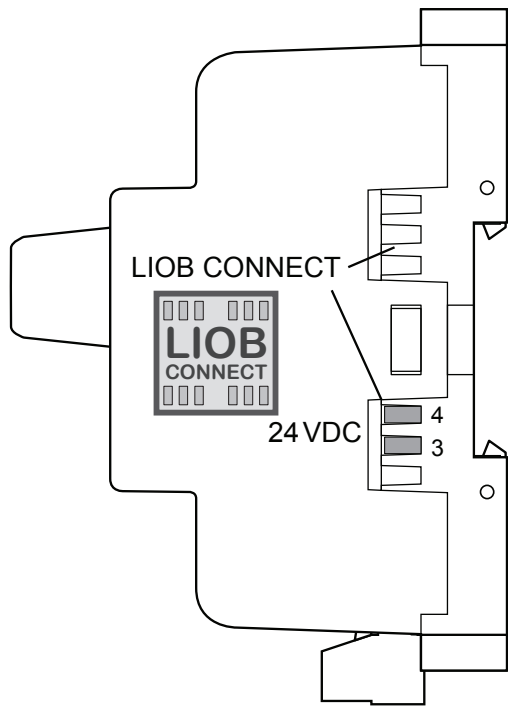

Connectors

POWER INPUT 85-265 VAC 50 / 60 Hz	1	Input N, neutral line
	2	Input L, phase line
OUTPUT 24 VDC max. 15 W (625 mA)	3	Output GND
	4	Output PLUS

Status LED

POWER	GREEN	Power supply OK
	LED is OFF	Main side is down, short circuit, or hardware failure

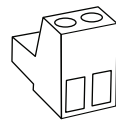

2 poles: Weidmüller BLZP 5.08/02/180

4.5 lb-in/0.5 Nm

0.2 - 2.5 mm²

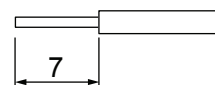

max. 4 L-IOB devices

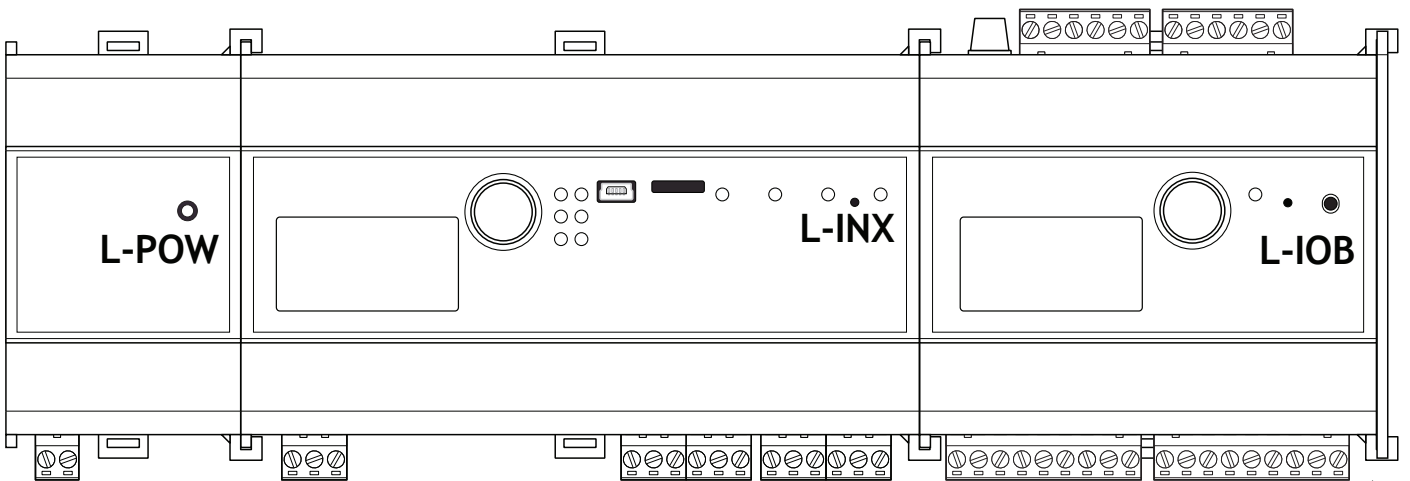

Install the cover on last device

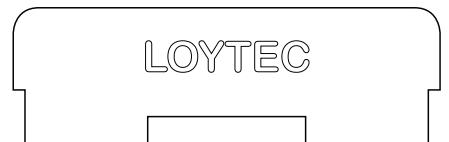

35 mm x 7.5 mm DIN rail (EN 50022, BS 5584, DIN 46277-3)

